



**FIELDMANN**<sup>®</sup>  
Home & Garden Performance

**20V**<sub>Li-ION</sub>  
**FASTPOWER**



FZP 70505-0

---

English .....	4-20
Čeština.....	21-38
Slovenčina .....	39-56
Magyarul .....	57-74
Polski .....	75-92

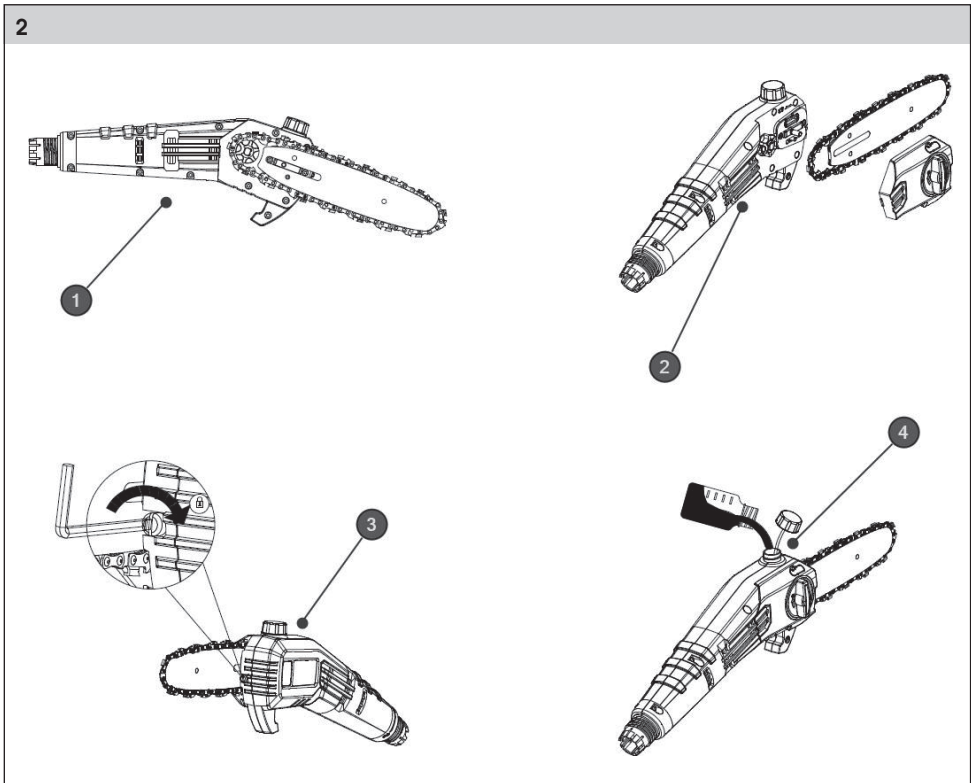
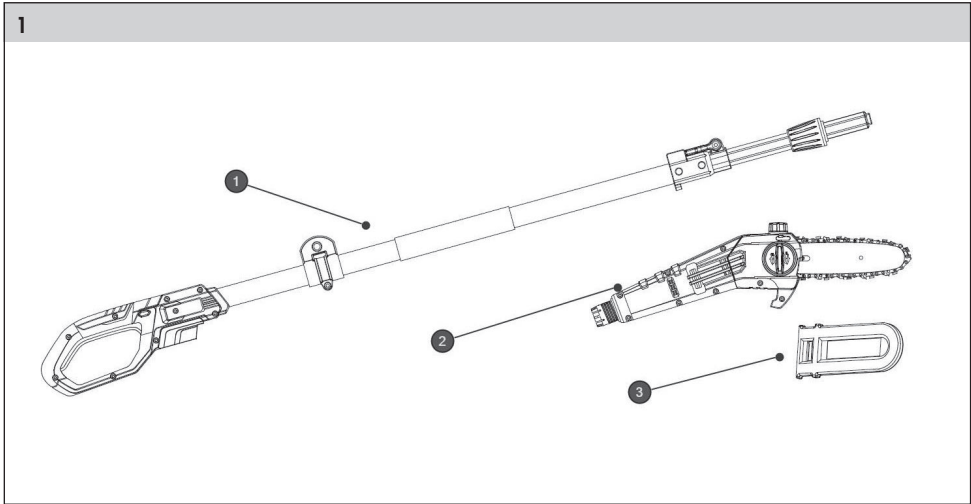

# Cordless Pole Saw **20V** FAST-POWER

## USER'S MANUAL

**Thank you for purchasing this Cordless Pole Saw. Before you start using it, please carefully read this user's manual and save it for possible future use.**

### TABLE OF CONTENTS



1. SAFETY INSTRUCTIONS.....	5
2. SYMBOLS.....	6
3. MACHINE DESCRIPTION AND PACKAGE CONTENT .....	8
4. SAFETY INSTRUCTIONS.....	9
5. SAFETY INSTRUCTIONS WHEN WORKING WITH POLE-MOUNTED PRUNER .....	11
6. OPERATION OF THE EQUIPMENT .....	12
7. TOOL CLEANING AND MAINTENANCE.....	14
8. SAWCHAIN SHARPENING.....	15
9. SAWCHAIN REPLACEMENT.....	16
10. STORAGE.....	17
11. TECHNICAL DATA .....	18
12. DISPOSAL.....	19
13. DECLARATION OF CONFORMITY .....	20

# 1. SAFETY INSTRUCTIONS

## **WARNING!**

Carefully read the instruction manual before use.

### **Important safety warnings**

-  Unpack the product carefully and be sure not to throw away any part of the package before having found all components of the product.
-  Keep the product in a dry place out of reach of children.
-  Read all cautions and instructions. The failure to adhere to warning cautions and instructions may result in an accident, fire and/or a serious injury.

### **Packaging**

The product is placed in a package preventing damage during transport. This package is a raw material therefore it can be handed-over for recycling.

### **Instructions for use**

Before beginning to work with the machine, read the following safety rules and instructions for use. Familiarize with operating elements and the proper use of the device. Keep the manual in a safe place for future reference. We recommend keeping the original package including the inner packaging materials, cash voucher and guarantee card for a period of warranty at minimum. For a case of transportation, pack the machine into the original box from the manufacturer, thus ensuring a maximum protection of the product during a possible transport (e.g. moving or sending into a service station).

 **Note:** If you hand the machine over to next persons, hand it over together with the manual. Adherence to the attached instructions for use is a precondition for the proper use of the machine. The operation manual includes also instructions for operation, maintenance and repairs.

**The manufacturer does not take any responsibility for accidents or damages resulting from the failure to adhere to this manual.**

## 2. SYMBOLS



**WARNING!**



Read the Instruction Manual attentively prior to use.



Protect the tool from the damp and never expose it to rain!

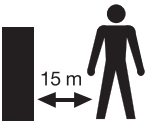

Keep other persons in distance!  
**WARNING!** When operating the device, take care that no other persons are nearby (safe distance: 15m). This is particularly valid for children and animals.



Use ear, eye and head protection.



**Wear work gloves.**



**Beware of falling branches.**



**Wear work shoes.**

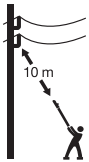

**WARNING!** When operating the device, take care that any power line is not close (safe distance: 10m).

## 3. MACHINE DESCRIPTION AND PACKAGE CONTENT

### Machine Description (see Fig. 1)

1. Handle with telescopic rod
2. Motor with chainsaw
3. Protective cover for chainsaw

### Machine Description (see Fig. 2)

1. Side view of the chainsaw
2. Motor, chainsaw sword including chain and side cover including chain tensioning wheel
3. Set screw for chain saw oil
4. Chain oil tank opening (65ml socket)

### Package Content

Remove the machine carefully from the packaging and check the completeness of the following parts:

- ✿ Pole pruner
- ✿ Bar
- ✿ Bar cover
- ✿ Chain
- ✿ Shoulder strap
- ✿ Instructions for use



## 4. SAFETY INSTRUCTIONS

### **ATTENTION!**

Familiarize yourself with all the warning and safety instructions and with the tool operating instructions.

### **ATTENTION!**



Failure to adhere to warning or safety instructions may result in electric shock, fire and/or serious injury.

### **ATTENTION!**





Keep all the warning and safety instructions in a practical place for future reference.

 **Note:** The term "power tool" in all the warning instructions specified hereafter means mains-operated (corded) power tool.

### **Work area safety**



-  Keep work area clean and well lit. Cluttered or dark areas at the workplace invite accidents.
-  Do not operate power tools in explosive atmospheres, such as in the presence of flammable liquids, gases or dust. Power tools create sparks which may ignite the dust or fumes.
-  Keep children and bystanders away while operating a power tool. Distractions can cause you to lose control over the tool.

### **Electrical safety**

-  Power tool plugs must match the mains outlet. Never modify the plug in any way. Do not use any adapter plugs with earthed (grounded) power tools. Unmodified plugs and matching outlets will reduce the risk of electric shock.
-  Avoid body contact with earthed or grounded surfaces, such as pipes, radiators, ranges and refrigerators. There is an increased risk of electric shock if your body is earthed or grounded. Do not expose power tools to rain or wet conditions. Water entering a power tool will increase the risk of electric shock.
-  Do not abuse the cord. Never use the cord for carrying, pulling or unplugging the power tool. Keep cord away from heat, oil, sharp edges or moving parts. Damaged or entangled cords increase the risk of electric shock.
-  When operating a power tool outdoors, use an extension cord suitable for outdoor use. Use of a cord suitable for outdoor use reduces the risk of electric shock.
-  If operating a power tool in a damp location is unavoidable, use a residual current device (RCD) protected supply. Use of residual current device (RCD) reduces the risk of electric shock.

 **Note:** The term "residual current device" (RCD) may be substituted by the term "ground fault circuit interrupter" (GFCI) or "earth leakage circuit breaker" (ELCB).

### **Personal safety**

-  Stay alert, watch what you are doing and use common sense when operating a power tool. Do not use a power tool while you are tired or under the influence of drugs, alcohol or medication. A moment of inattention while operating power tools may result in serious personal injury.
-  Use personal means of protection. Always wear eye protection. Safety equipment such as dust mask, non-skid safety shoes, hard hat, or hearing protection used in conformity with the working conditions will reduce personal injuries
-  Avoid accidental starting. Ensure the switch is in the off-position before connecting the battery, storing or carrying the power tool. Carrying power tools with your finger on the switch or plugging in power tools that have the switch on invites accidents.

- ✿ Remove any adjusting tools or wrenches before turning the power tool on. An adjusting tool or wrench left attached to a rotating part of the power tool may result in personal injury.
- ✿ Do not overreach. Keep proper footing and balance at all times. This enables better control of the power tool in unexpected situations.
- ✿ Dress properly. Do not wear loose clothing or jewellery. Keep your hair, clothing and gloves away from moving parts. Loose clothes, jewellery or long hair can be caught in moving parts. If devices are provided for the connection of dust extraction and collection facilities, ensure these are connected and properly used. Use of these devices can reduce dust-related hazards.

### **Power tool use and maintenance**

- ✿ Do not force the power tool. Use only the correct power tool for your application. The correct power tool will do the job better and safer at the rate for which it was designed.
- ✿ Do not use the power tool if the switch does not turn it on and off. Any power tool that cannot be controlled with the switch is dangerous and must be repaired.
- ✿ Unplug the power cord from the mains outlet before making any adjustments, changing accessories, or storing power tools. Such preventative safety measures reduce the risk of starting the power tool accidentally.
- ✿ Store idle power tools out of the reach of children and do not allow persons unfamiliar with the power tool or these instructions to operate the power tool. Power tools are dangerous in the hands of untrained users.
- ✿ Maintain power tools. Check for misalignment or binding of moving parts, pay particular attention to cracks, breakage of parts and any other condition that may affect the power tool's operation. If damaged, have the power tool repaired before use. Many accidents are caused by poorly maintained power tools.
- ✿ Keep cutting tools sharp and clean. Properly maintained cutting tools with sharp cutting edges are less likely to bind and are easier to control.
- ✿ Use the power tool, accessories and tool bits etc., in accordance with these instructions and in the manner intended for the particular type of power tool, taking into account the given working conditions and the work to be performed. Use of the power tool for operations other than those for which the power tool is intended could result in hazardous situations.

### **Service**

- ✿ Have your power tool serviced by a qualified repair person using only original replacement parts. This will ensure that the safety of the power tool is maintained.

### **Storage**

- ✿ only carry and store the tool with the scabbard fitted
- ✿ carefully clean the tool and carry out adequate maintenance before storing
- ✿ before carrying, secure the tool against fuel leakage, damage or injury

### **Use and treatment of the cordless tool**

- ✿ Only charge the batteries with chargers recommended by the manufacturer. A charger that is suitable for a certain type of battery creates a fire hazard when used with other batteries.
- ✿ Only use the batteries provided for this purpose in the power tools. The use of other batteries can lead to injuries and fire hazards.
- ✿ Keep the unused battery away from paper clips, coins, keys, nails, screws or other small metal objects that could cause the contacts to be bridged. A short circuit between the battery contacts can result in burns or fire.

- ✿ If used incorrectly, liquid can leak out of the battery. Avoid contact with it. In case of accidental contact, rinse with water. If the liquid gets into your eyes, get additional medical help. Leaking battery fluid can cause skin irritation or burns.

## 5. SAFETY INSTRUCTIONS WHEN WORKING WITH POLE-MOUNTED PRUNER

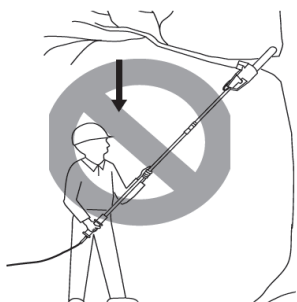

Never stand directly under the branch you are cutting. Always stand outside the area of falling chippings.



Never work from a ladder or other unstable equipment while working with a chain saw. Always grasp the chain saw with both hands. While cutting, apply firm and continuous pressure on the chain saw but do not try to force the chain saw through the wood being cut. Do not use the chain saw for cutting branches having larger diameter than the length of the guide bar.



While cutting, prevent movement of persons near the chain saw. Ensure safe movement of persons in sufficient distance from the cutting point.

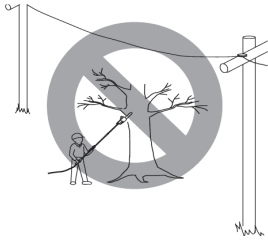

Do not use the chain saw near cable, power and telephone lines. Maintain distance of at least 10 m from all electrical power lines while working with a chain saw.

## 6. OPERATION OF THE EQUIPMENT

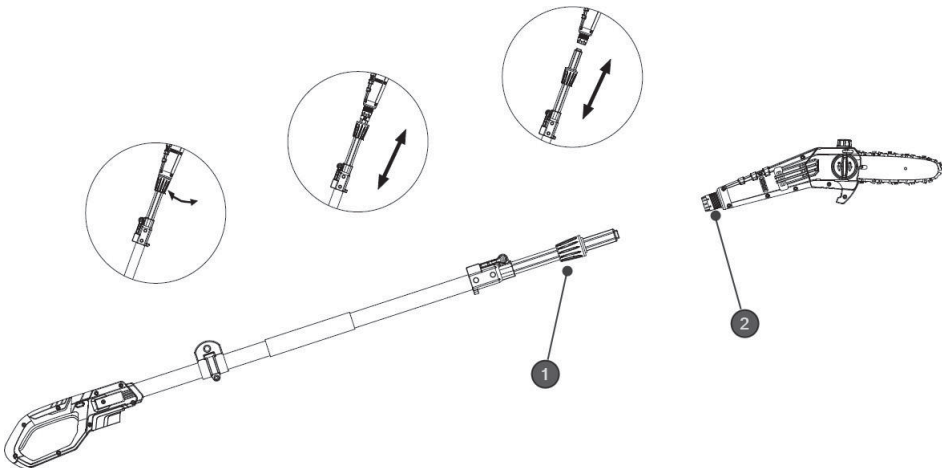

Figure 3: Uninstalling the motor with cutting head from the telescopic rod for space-saving storage or for transportation.

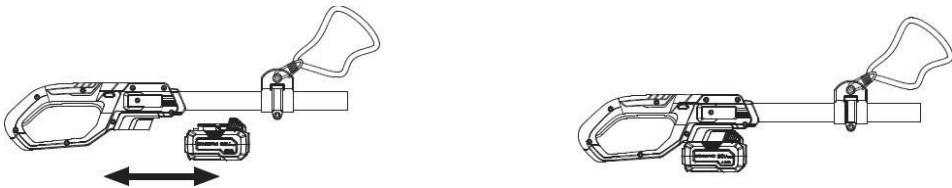

Figure 4: Installation of the battery (battery not included in the package)

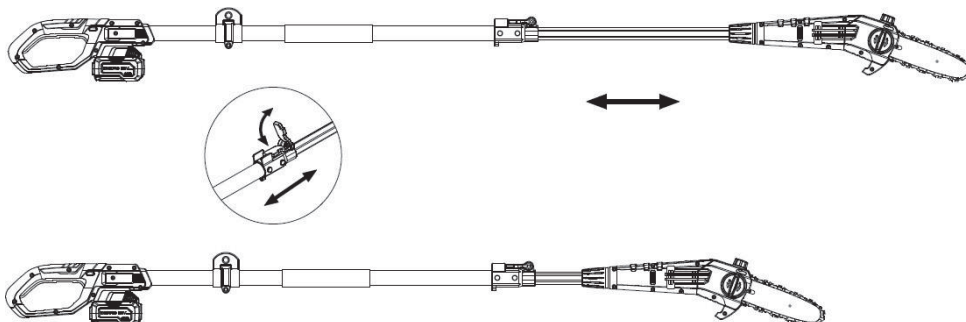

Figure 5: Extension of the working area by 70cm

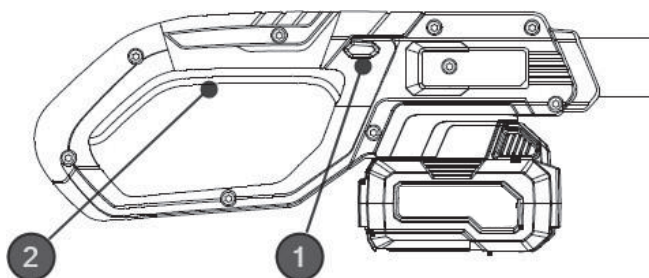

Figure 6: Safety button and on / off switch for using the pole pruner

### **Switch device on / off**

Insert the battery into the designated rail. Then press the safety button (Figure 6, point 1) sideways, only then can you operate the on / off switch (Figure 6, point 2). The device now starts. When you release the on / off switch, the device stops working. Attention: The cutting tool can still run a little.

## 7. TOOL CLEANING AND MAINTENANCE

### Cleaning the chainsaw body

Keep the chainsaw body clean. When cleaning, use a soft cloth soaked in a soap water. Use this cloth to carefully clean the chainsaw body.

### Guide bar maintenance

- ✿ Most problems with the guide bar occur as a result of uneven wear and tear. Uneven wear and tear occurs mostly due to incorrect chain sharpening and incorrect adjustment of the raker. If the bar is worn out unevenly, the guiding groove is getting wider (See Figure). Consequently, it results in chain rattling and rivets falling off. It is impossible to make straight cuts with the saw. In such case replace the guide bar by a new one.
- ✿ Before chain sharpening, always check the state of the guide bar. Using worn out or damaged guide bar is very dangerous. Using worn out or damaged guide bar will result in chain damage. Cutting using such tool will also be significantly more difficult and laborious.

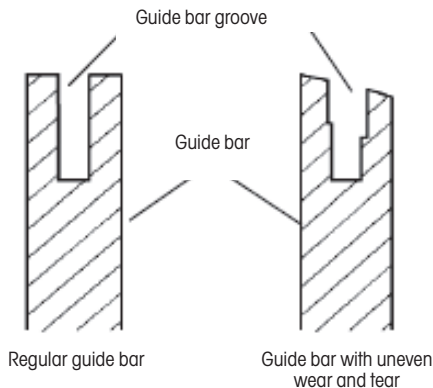

### Regular maintenance of the guide bar

- ✿ Dismantle the guide bar (19) from the chainsaw body.
- ✿ Regularly remove wood dust from the guide bar groove. While cleaning, use a scraper (29) or a wire (see Fig. 13).
- ✿ At the end of each working day, clean the oil grooves (30).
- ✿ Remove burr from the sides of the bar (31). Grind in the side edges using a flat file (32).  
Replace the guide bar, if:
  - it is bent or cracked
  - its groove is severely damaged or worn out

**Note:** When replacing the guide bar, follow the instructions specified in the Chapter Spare parts and accessories. Correct bar type is available in the List of Parts.

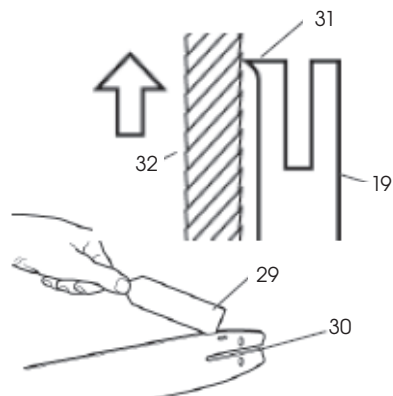

## 8. SAWCHAIN SHARPENING

Keep the saw chain sharp. Cutting will be significantly faster and particularly safer. Dull chain increases wear and tear of the sprocket, guide bar, chain and drive. If you have to force the chainsaw while only wood dust and a few chippings are produced while cutting, it means that the chain is dull.

### Equipment required for saw chain sharpening

Purchase the following equipment from your local vendor, tool shop or hobby market.

- ✿ Round file 5/32"
- ✿ Raker
- ✿ File guide rail 5/32"
- ✿ Chops
- ✿ Middle-sized flat file

### Saw chain sharpening

Use guide rail (33) (see Fig. 14) for filing under the angle of 30° (mark A, Fig. 14).

- ✿ Adjust the saw chain tension to the correct level.
- ✿ Fix the guide rail into the chops to ensure the chain is in a stable position

 **Note:** Do not fix the chain itself.

- ✿ Press the round file 5/32" (34), inserted in to the guide rail (33), into the groove between the upper plate and the chain raker. The chain should touch both the upper plate and the raker (see Fig. 14).

 **Note:** File in the centre of the guide bar.

 **Note:** The figure shows the position of the guide rail of the file and the teeth filing direction on the left side of the chain.

- ✿ Place the file guide rail to the desired angle (mark A, Fig. 14). Check whether the mark 30° on the file guide rail is aligned with the centre of the guide bar. This way you make sure you are filing under the angle of 30°.

1. Right-hand side of the chain
2. Upper plate, right-hand side of the chain
3. Raker, right-hand side of the chain
4. Groove
5. Raker, left-hand side of the chain
6. Groove
7. Upper plate, left-hand side of the chain

- ✿ File the tooth from inside out (in the direction B, Fig. 14) until it is sharp. File only in this direction.

 **Note:** Two or three file strokes should suffice to make the tooth sharp.

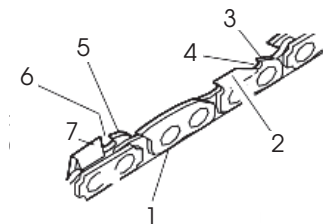
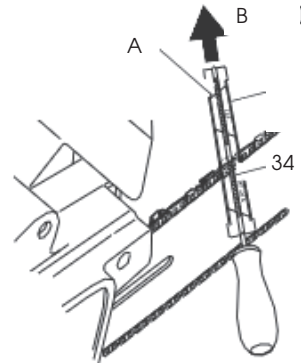

### Raker filing

Sharpening of the chain teeth will result in reduced tolerance of the raker. After each second or third sharpening, it is necessary to adjust the raker.

- ✿ Place the tool for raker modification (.025") (35) firmly onto the top edge of two teeth. Make sure the groove of the tool snapped into the groove of the raker (36) (see Fig. 15).
- ✿ Use middle-sized flat file (32) (see Fig. 15). File the raker (37) down to the level of the tool for raker modification.
- ✿ Remove the tool for raker modification. Using a flat file (32) round off the front side (38) of the raker (see Fig. 16).

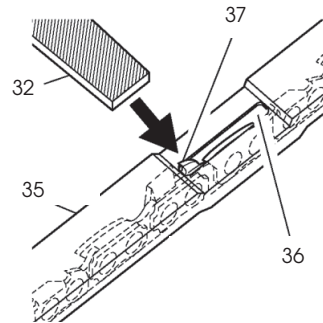

**Note:** After a few manual sharpening hand the saw chain for sharpening to an authorised service centre or sharpen it using a special sharpening machine. This way you will restore even sharpening of all teeth.

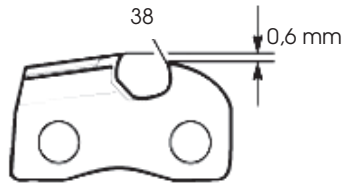

## 9. SAWCHAIN REPLACEMENT

**⚠ ATTENTION!** When replacing the saw chain, do not fix the chainsaw or the guide bar into the chops.

Always replace the chain if the teeth are excessively worn out or cannot be sharpened or if the chain breaks. Use only original replacement chain according to specification in this instruction manual. When replacing a chain, always replace the sprocket wheel too. This way you ensure the correct position of the chain during movement. (Note: The specification of the correct chain and sprocket type is available in the List of Parts.)

When performing the following steps, make use of the drawing in Fig. No. 1.

- ✿ Loosen and remove the guide bar bolt.
- ✿ Remove the sprocket cover.
- ✿ Remove the saw chain.
- ✿ Place the new chain around the sprocket wheel, along the top groove of the guide bar and around the guide bar nose.

**Note:** Make sure the cutting edges of the chain are facing in the correct direction. Position the chain so the cutting edges on top of the guide bar face to the guide bar nose (40) (see Fig. 17 and arrow on the saw side cover).

- ✿ Before placing the sprocket cover into position, check whether the adjusting tip is inserted into the adjusting hole of the guide bar.
- ✿ Reinstall the sprocket cover back to the saw body.
- ✿ Attach the sprocket cover using the guide bar bolt.

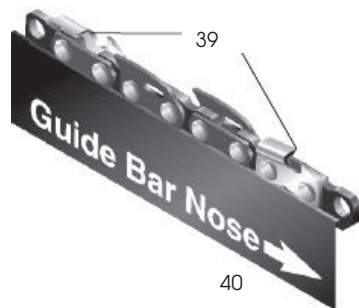



**⚠ ATTENTION!** Use only your hand while tightening the bolt.

- ✿ Adjust the tension of the saw chain.
- ✿ Tighten the guide bar bolt using a hexagonal wrench.

**⚠ ATTENTION!** Make sure you did not place the saw chain onto the guide bar in the opposite direction. Otherwise, the saw will produce excessive vibrations and will not cut.

## 10. STORAGE

If you do not use the saw for a period exceeding 30 days, proceed as follows.

- ✿ Empty the oil container.
- ✿ Remove and clean the guide bar and the chain. Immerse the guide bar and the chain in a paraffin-based or soap-based cleaning bath.
- ✿ Then dry the guide bar and the chain.
- ✿ Place the chain into a container filled with oil. This will prevent it from corroding.
- ✿ Slightly apply oil onto the guide bar.
- ✿ Wipe the chainsaw body with a cloth. When cleaning, use a soft cloth soaked in a soap water.
- ✿ Store the chainsaw
  - in higher racks or in locked premises out of the reach of children
  - in a dry place

## 11. TECHNICAL DATA

<b>MODEL</b>	<b>FZP 70505-0</b>
Rated voltage	20 V
Chain speed	5m/s l
Oil tank capacity	65 ml
Cutting length	200mm
Max. operating duration with a full battery	25 min (2 Ah), 50 min (4 Ah)
Weight	3,5 kg

### Accessories

<b>Item number</b>	<b>Accessory</b>
FDUZ 79020	Battery pack 2 Ah
FDUZ 79040	Battery pack 4 Ah
FDUZ 79100	Fast charger
FDUZ 79110	Fast dual charger

## 12. DISPOSAL



The machine, rechargeable batteries, accessories and packaging should be sorted for environmentalfriendly recycling.

Do not dispose of power tools and batteries/rechargeable batteries into household waste!

### Only for EC countries:



According to the European Guideline 2012/19/EU, power tools that are no longer usable, and according to the European Guideline 2006/66/EC, defective or used battery packs/batteries, must be collected separately and disposed of in an environmentally correct manner.

#### **INSTRUCTIONS AND INFORMATION ON DISPOSAL OF USED PACKAGING.**

Put any used package material to the place determined by the municipality for waste disposal.

#### **DISPOSAL OF USED ELECTRIC AND ELECTRONIC EQUIPMENT**

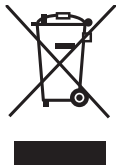

This symbol on products or accompanying documents means that used electric or electronic products must not be put to ordinary municipal waste.

Hand over such products to determined collection points for proper disposal, restoration and recycling. Alternatively, in some countries of the European Union or other European countries you can return your products to your local dealer when you buy an equivalent new product. By dutiful disposal of this product you can preserve precious natural resources and you help prevent any potential adverse effects on the environment and human health which could be the results of wrong waste disposal. Ask your local authority or the nearest collection point for additional details. In case of improper disposal of this waste kind penalties can be imposed in accordance with national regulations.

#### **For companies in the European Union countries**

Should you want to dispose of electric and electronic devices, ask your dealer or vendor for necessary information..

#### **Disposal in other countries outside the European Union**

Should you want to dispose of this product, ask your local authorities or your dealer for necessary information about disposal method.



This product fulfils all basic requirements of the EU directives that apply to it.

Text, design and technical specifications can change without prior notice and we reserve the right for their change.

User manual in the original language.

# 13. DECLARATION OF CONFORMITY

# FAST®

FAST ČR, a.s.  
Černokostecká 1621, 251 01 Říčany, Czech Republic  
tel.: +420 525 204 111, fax: +420 525 204 110

## EU Declaration of Conformity

**Product/ brand:** Cordless pole saw / FIELDMANN

**Type/ model:** **FZP 70505-0** as factory model D06101700  
DC 20V (battery powered), cutting length 200mm, Class III, IPX0  
 $L_{pa} = 84\text{dB(A)}$ ,  $L_{wa} = 91\text{dB(A)}$

**Manufacturer:** FAST ČR, a.s.  
Černokostecká 2111, 100 00 Praha 10, Czech Republic  
VAT no: CZ26726548

**The product is inline with directives and regulations listed below:**

Directive MD 2006/42/EC  
Directive EMC 2014/30/EU  
Directive NEOE 2000/14/EC  
Directive RoHS 2011/65/EU

**and norms:**

EN 62841-1:2015  
EN 62841-4-2:2019  
EN 55014-1:2017  
EN 55014-2:2015



**Place of issuance:** Prague

**Name:** Ing. Zdeněk Pech  
Chairman of the Board

**Date of issuance:** 22. 7. 2020

**Signature:**

**FAST®** FAST ČR, a.s. ©  
Černokostecká 1621, 251 01 Říčany  
IČO: 26726548 tel.: +420/ 323 204 111  
DIČ: CZ26726548 fax: +420/ 323 204 110

**IČO:** 26 72 65 48, **DIČ:** CZ-26 72 65 48

**Bankovní spojení:** Komerční banka Praha 1, č.ú. 89309011/0100, Česká spořitelna Praha 4,  
č.ú. 2375682/0800, ČSOB Praha 1, č.ú. 8010-0116233383/0300